

METALEX

20

Metalex brings you over 20 years of experience to the steel structural fabrication industry.

We adhere
to stringent
quality!

Company Profile

Contents

3

About
Metalex

4

Services we
offered

7

Organisational
structure

8

Resources

10

Certificates and
Affiliations

13

Projects
portfolio

28

Other projects

34

Location Map

About Metalex



Metalex Trading and Contracting Company was established in the year 1992. It has grown up from strength to strength and the present total employees are around 300. The covered area of our facility including support buildings is 7000 Sq.m over a land plot size of over 12200 Sq.m.

Metalex's philosophy is to provide a comprehensive and professional project service conforming to international standards. Since its inception, the company has focused its attention on specialized fabrication projects involving steel and metal work. Our mission is the uncompromising commitment to achieving high standards of quality and service. This has helped the company to earn good reputation and forge long term relationships with its customers.

Metalex has in recent years developed an excellent track record in a wide variety of structural and architectural work including heavy steel structures, steel and metal work from petrochemical industry, tensile structures and shades, canopies, metal work for sewerage and water supply projects.

We trust this booklet will give you fillip to talk to us further when we will be pleased to explain more about the specialized services we are able to offer and how our philosophy and experience can be applied to the benefit of future projects.

Ghassan Khader
General Manager

Services we offered

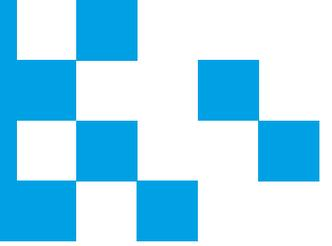

Tensile structures and Shades

Fabrication and erection of Tensile Structures and Shades, using framed steelwork, wire rope cables and polyester reinforced fabric.



Steelwork for Multi-storey Buildings

Design, fabrication, supply and erection of steel structures and fire proofing of Multi storey buildings.



Steelwork for Industrial Buildings

Design, fabrication, supply and erection of Steel structures and fire proofing of Industrial buildings. Cinemas and Roof structures.

Our ability to carry out in house design and detailing allows us to produce cost effective solutions to structural problems. This results in a cost benefits to our clients and end users.

With a view to provide professional engineered services & customer satisfaction of the highest degree. Each service is adequately handled by professionals exemplary in their respective fields.

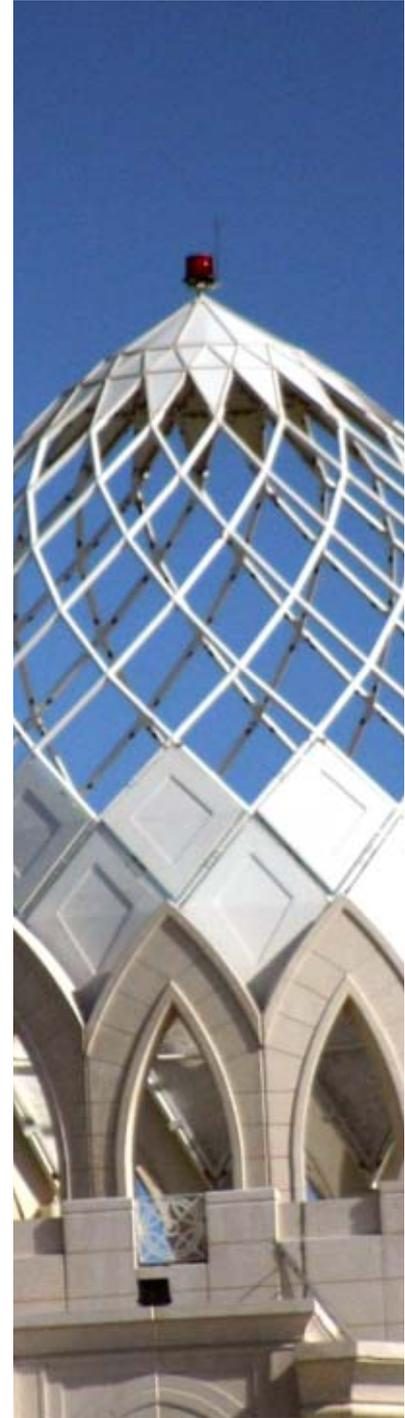

Pedestrian Bridges and Staircase

Design, fabrication, supply and erection of steel structure for Pedestrian bridges, Access bridges and Stair cases.

Communication Towers and Monopoles

Design, fabrication, supply and erection of galvanised steel tower and monopoles.

Architectural metalwork

Design, fabrication and erection of structural and Architectural Metal works with highest degree of finishing and longevity.

Our services are fully equipped with all necessary infrastructures which can give you total solutions of Design, Fabrication, Final Construction and delivery.



Steel Stairs case and Handrails

Design, Fabrication and erection of Stairs, Handrails, Spiral Stairs, Fire escape Stairs made of Mild steel and stainless steel.



Aluminium Louvers , Handrails

Design, fabrication, supply and erection of wall louvers using steel frame and in-house designed aluminium louver profile.

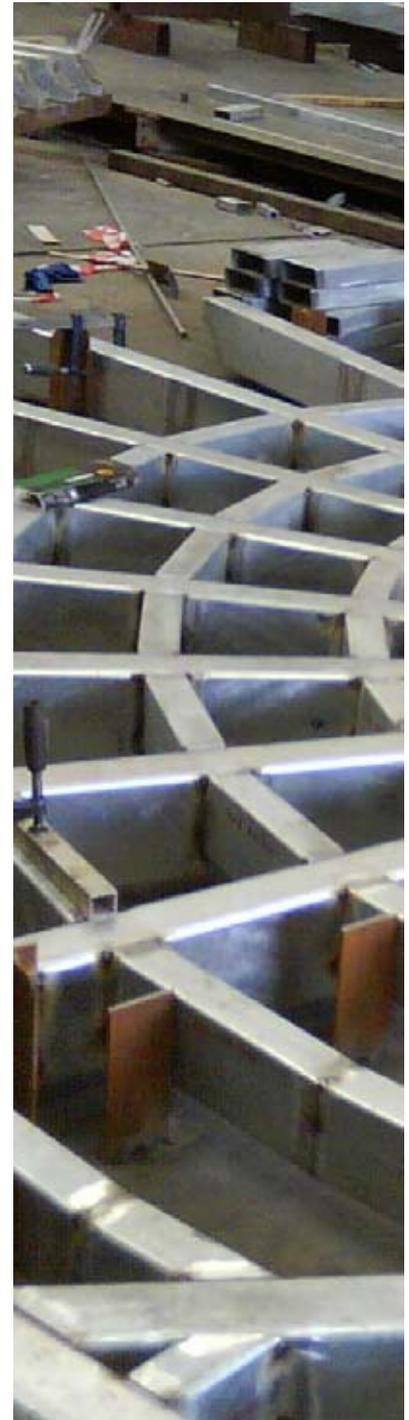

Miscellaneous metalwork

Metal works such as Canopy, Hand railings, Gratings, SS Cladding, Open mesh floorings and Pit covers for Sewage and water supply projects.

Organisational structure

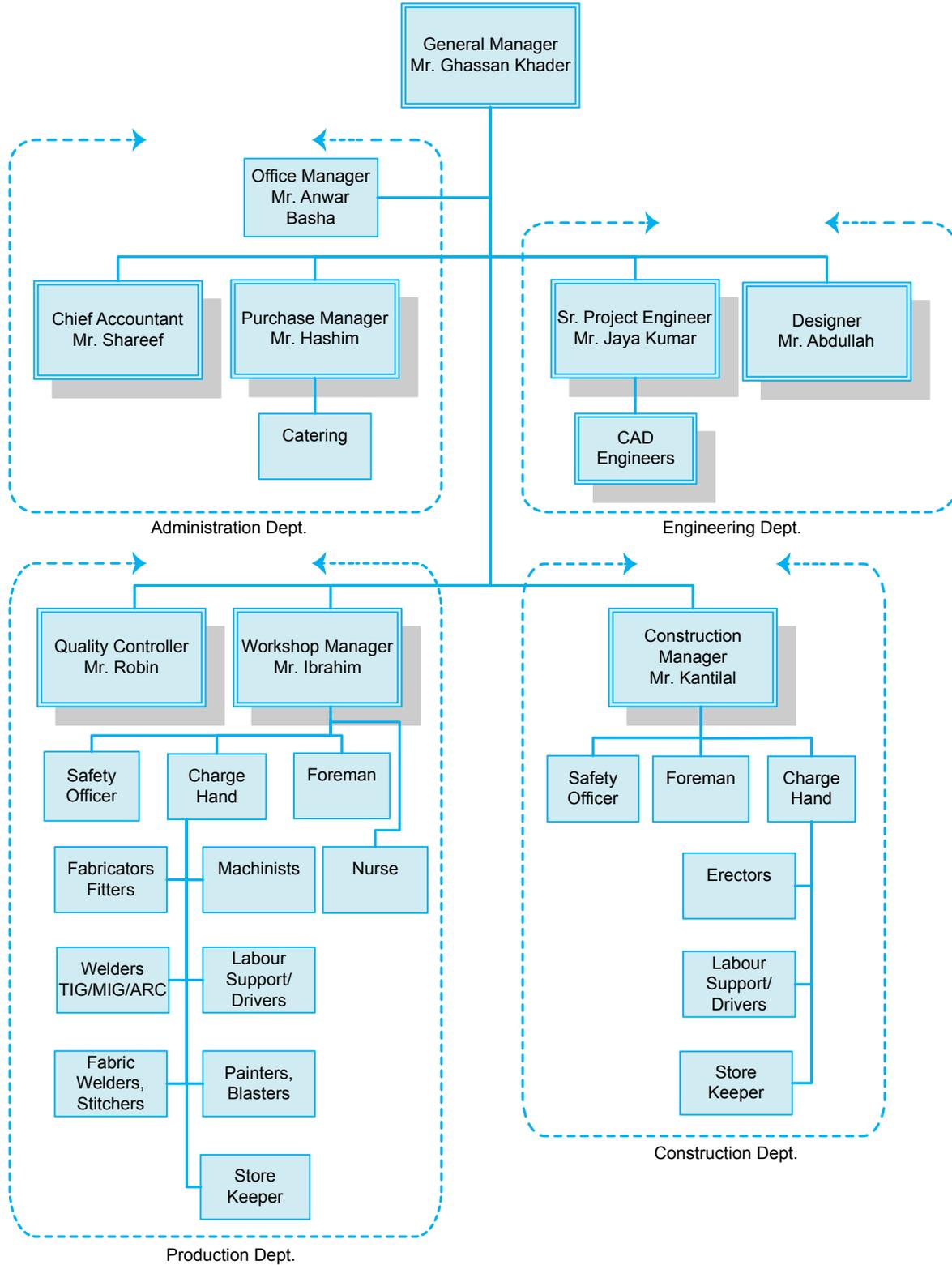

Machineries

FABRICATION	NOS.	FABRICATION	NOS.	WELDING	NOS.	LIFTING/OTHERS	NOS.	BLASTING & PAINTING	NOS.
Cold Saw Capacity UB 900	1	Lathe	1	Arc 500/400amp Welding	24	Fork Lift Up to 5 Ton	7	Compressor 600 Cfm	1
Band Saw Capacity Upto 630 mm	4	Thread Rolling	2	MIG Welding 400 amp	14	Overhead Crane 5.0 Ton	4	Compressor 300 Cfm	2
Belt Grinder	5	Shear 6 mm	1	TIG welding 350/150 amp Ac/ Dc	4	Gantry Cranes 5.0 T	1	Blasting Cone 250 kg	1
Bench Grinder	2	Shear 12 mm	1	Diesel Welding Machine	4	Mobile Crane 16 T	1	Air less Spray Unit	3
Magnetic Stands	7	Press Brake 6mm	1	Submerged Arc Weld M/c 1000 amp.	4	Plate compactor	1	Pot Spray Unit	1
Pillar Drills	2	Press Brake 12mm	1	Stud welding upto 25mm	6	Electric Generator 90 KVA	1	Spray Guns	3
Radial Drill	2	Plate Roll 6 mm	1	Plasma Cutting	1	Generator 160 KVA	1	Electric Compressor	4
Profile Gas Cutting	1	Plate Roll 19 mm	1	Spot Welder	1	Generator 350 KVA	3	Thermal Spray M/c	1
Kobra Cutting	4	Fly press 20 ton	2	RH PVC Welding M/c	2	Generator 250 KVA	2	Roto Blasting	2
Cobra - 400 Aluminium cutting	2	Swaging	2	Hot air PVC Welding M/c	1	Tensile Testing Machine	2	Sand Blast	2
Steel worker with Press Brake (I00T)	1	Thread Cutting	1	High Frequency fabric welding M/C	4	JCB Telescopic Mtrl. Handler	2	Fire Proofing M/c	5
Portable punching up to 20mm x 16mm	7	Milling m/c	1	TRANSPORT		Bobcat Skid Steer Loader	4		
Pipe Bending	1	Turn table	1	Pickup Truck 3.5 Ton	5	Man Lifter	3		
Decking & roof profile rolling	1	Pipe Cutter 14"	1	Pickup Double Cabin	7				
Z and C section rolling M/c	1	Plasma Gantry	1	Saloon	7				
Standing Seam M/c	2	General Tools Hand tools	2	4x4 Wheel Drive	7				
Fly Press 125 Ton	1	CNC Water Jet Cutting M/C	3	Bus 64 Seater	1				
Hydraulic Press	2	CNC Grooving	2	Bus 53 Seater	1				
CNC Plasma Cutting M/C	2	CNC Laser Cutting M/C	1	Micro Bus	6				
Pipe Cutting M/C	1	Plasma Table	1	TRAILER 40 Feet	3				

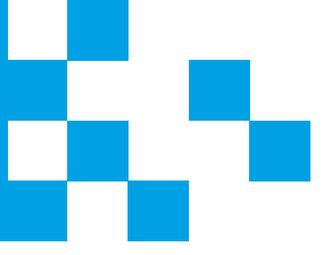

Manpower

DESIGNATION	NOS.	DESIGNATION	NOS.
General Manager	1	Surveyor	1
Design Engineer & Tech. Manager	1	Crane Operator	2
Secretary / Office Manager	1	Machinist	2
Purchase & Personal Affairs Manager	1	Mechanic	3
Chief Accountant	1	Electrician	3
Public Relation Officer	1	Driver	15
Design Engineer	2	Painter	4
Sr. Project Engineer	1	Fabricator	19
Construction manager	1	Erector	42
Workshop Manager	1	Welder	14
Engineer / CAD Draftsman	7	Sand Blaster	3
QA/QC Engineer	3	Moulder	1
Foreman	7	Mason	1
Transport In-Charge	1	Cook	5
CNC Operator	4	Gate Keeper	1
Sheet Metal In-Charge	1	Office Boy	4
Painting In-Charge	1	Safety Officer	1
Store Keeper	3	Labours	133



292
Total Employees

Certificates & affiliations

Membership



We believe in association with corporate bodies and continual learning is the key to success and sustainable growth.

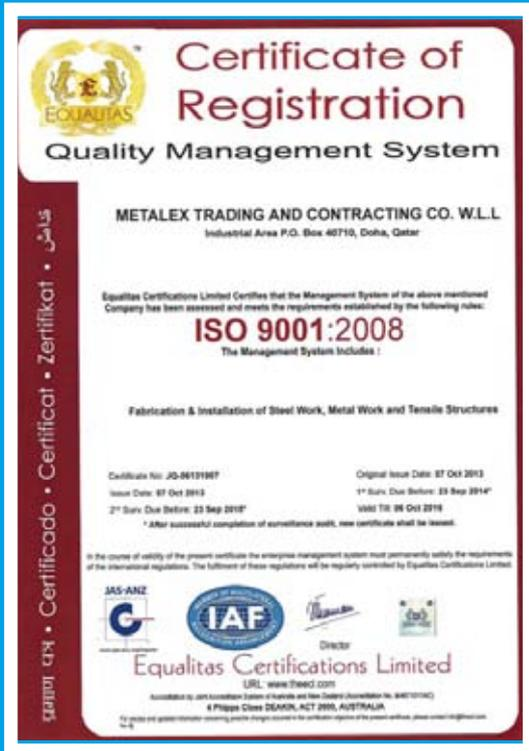

Metalex's commitment to quality, conformance to standards and customer satisfactions helped to achieve ISO certificate of registration.

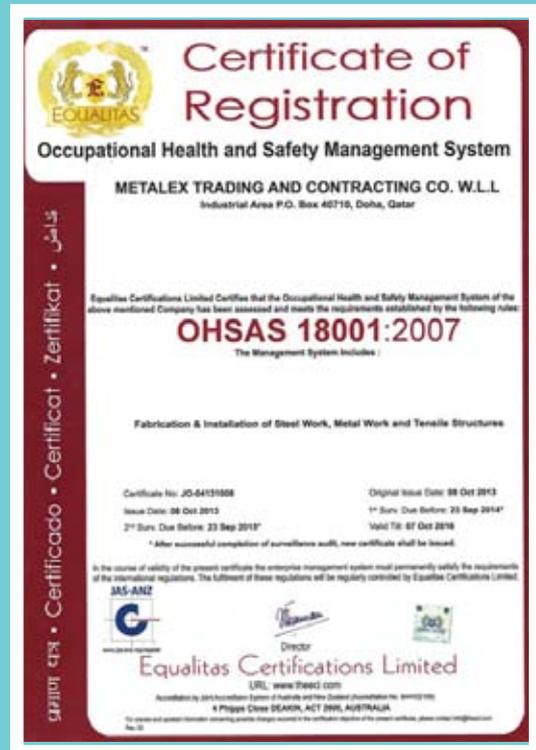

Certificate of appreciation

For contributing to the success of 15th Asian Games Doha 2006.



Business Excellence Award

Best Sub Contractor of the year 2013,
from Gulf Contracting Co. (W.L.L.)

Metalex has been focusing on delivering high-quality services within budget and on time. Metalex's technical expertise and modern production capabilities will complement the customers, with changing market needs and technologies. Metalex is committed to policies of investments and innovation within the company, to refine and enhance the services we offer to our clients.

Projects portfolio

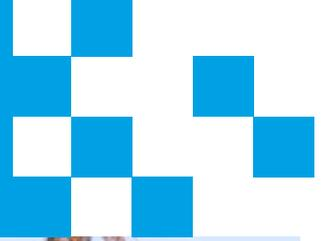

A'ayan Tower

Floor Count: 48, Finished Year: 2009
Main Contractor: HBK Cont. Co.



Lagoon Twin Tower

Floor Count: 34, Finished Year: 2009
Main Contractor: Marbu Cont. Co.





Palm Twin Tower

Floor Count: 57, Finished Year: 2011
Main Contractor: Al Seal Cont.

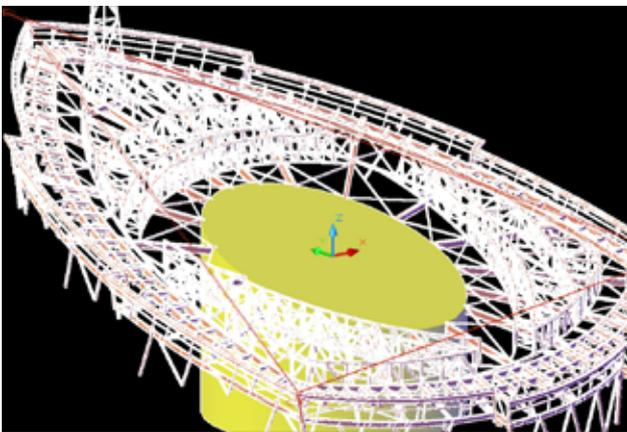

Al Bidda Tower

Floor Count: Top 4 floors, Finished Year: 2010
Main Contractor: HIGGS & HILL





Business Park

Finished Year: 2010

Main Contractor: Redco



Nobu Restaurant

Finished Year: 2013

Main Contractor: TERNA





Medina Centrale Building-7

*Steel Framing and Roof Structure
Main Contractor: Power Line Engg.*



Oryx Rotana Hotel

*Steel support for Hanging wenge feature and Indoor Canopy
Main Contractor: Gulf Cont. Co. W.L.L*

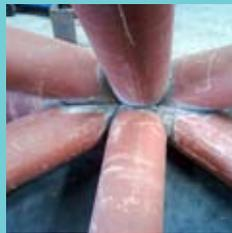

Villagio Mall Cinemas - 13 Scr.

*Steel Framing and Roof Structure
Main Contractor: Businesses Trading
Company*

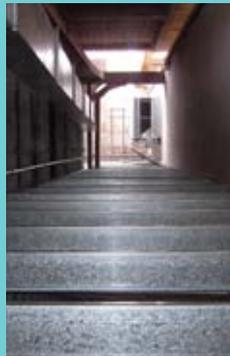
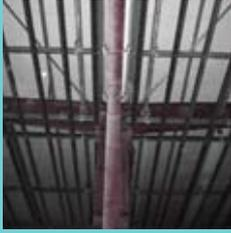

Gulf Mall Cinemas 13 Screens

*Steel Framing, Acoustic wall, Roof Structure
and Fire Proofing
Main Contractor: QBIC*





Communication Tower
For Ministry of Interior



Communication Tower
For Ooredoo (formerly Qtel)





**Multi Storey
Car Parking**
*Roof Structure, Standing Seam, Roof
Cladding and Pedestrian Bridge*
Main Contractor: Boom General Contractors

**Bicycle Track
Asian Games 2006**
Steel Structure for bicycle track for DAGOC



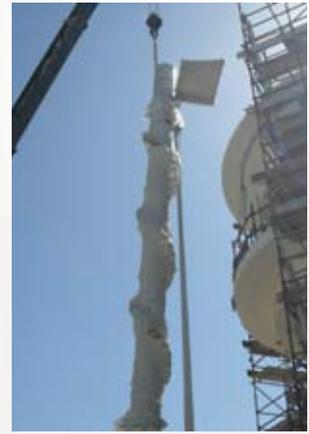

Spiral Stair Case
*at Coast Guard Watch Tower Bld. for
CCC & TEYSEER JV*



SS & MS Staircase
for Qatar Academy, Al Wakra

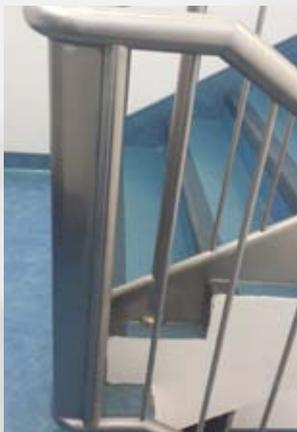



Pedestrian Bridge

for Qatar Racing Club



Access Bridge

at Lacegal Hotel for Khatib & Alami

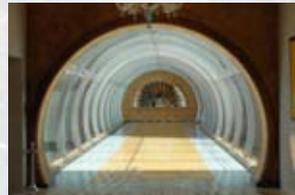

Pedestrian Access Bridge

for Hamad Medical Corporation



Pedestrian Bridge, Eve Canopy & Lift Frames

Bridge 11 Nos. ,Lift Frame 4 Nos for Supreme Education Council Head Qtrs. for Al Huda Engg.



Wall Louvers

for Transformers in Wajba

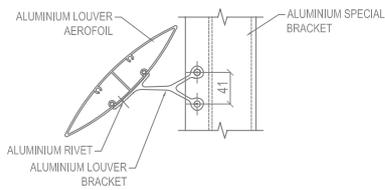
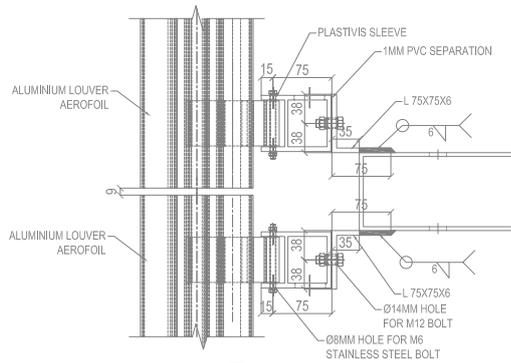
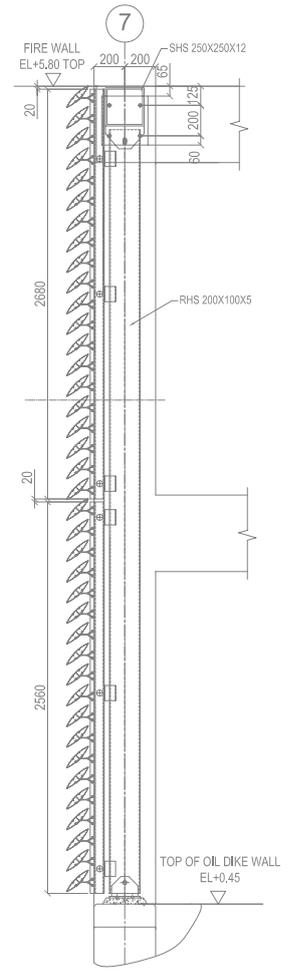

Tensile Canopies and Car Park Shade at Ras Laffan Industrial City West Security Gate

Main Contractor: KBAS Contracting, Trading & Industrial Co.





Tensile Canopy

for Private Gas Station at Al Rayyan

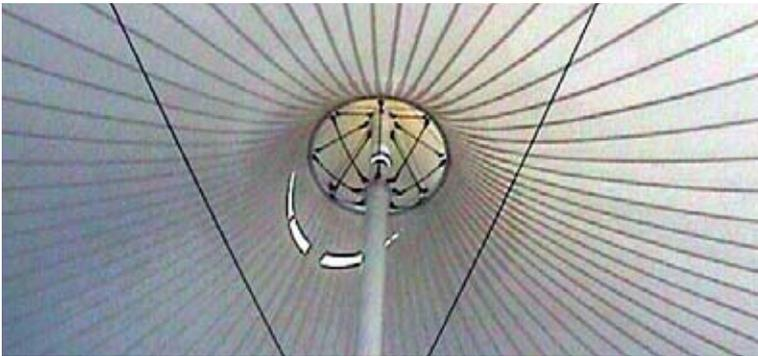

Fabric tent and Shade Ceiling Structure

Junior school sports facilities & cafeteria
Main Contractor: MIDMAC

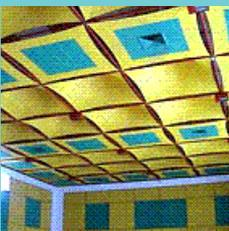

Tensile Canopy

at Alfardan

Main Contractor: QBEC



Tents and Framing

for Al Jazeera School

Main Contractor: QBEC

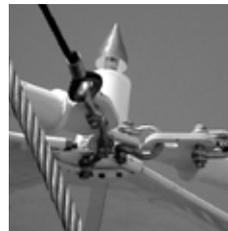



Tent Shade at Play Area
for Qatar Foundation.
Main Contractor: Midmac Contracting Co. WLL.



Tensile Canopy and Car Park Shade
for New Training Center
Main Contractor: Al Mana Engg.





Steel Dome

2 Nos. for Four Season Hotel
Contractor: ALUTECH



SS Canopy, Brass Gates & Wall Panels

for Msheireb, Down Town Doha
Contractor: ALUTECH



Other projects

PROJECT	CLIENT	PRIME CONTRACTOR	LOCATION	SCOPE OF WORKS	YEAR	VALUE
Aluminium checker plates	Qafco	Manco	Umm Said	Design and supply of culvert covers	1993	560000
Aluminium Walkway	H.E. The Heir Apparent	Contraco	Al Wajbah	Fabrication and erection Walkway , Special suspension and miscellaneous steelwork	1995	520000
Marine workshop	Qatar Gas	Al Muftah	Ras Laffan	Fabrication and erection of shed	1997	1870000
Equipment supports	MEW	Lahoud Engineering	Ras Abu Aboud	Fabrication of Pipe and equipment support	1996	930000
Stables	He. Sh. Mohammad Bin Khalifa	Ramco	Shahaniyah	Fabrication of steelwork for Stables	1997	865000
Shed	Qatar Precast	Metalex	Industrial Area	Fabrication and erection of steel shed 168 m x22m	1997	1500000
Sewage Works	MEW	Marbu	Misc.	Aluminium Hand Railing, Grating , and lifting equipment	1997	500000
Wajbah Palace	S.P.O.	A.K.C.	Al-Wajbah	Welded aluminium Hard scapping	1997	1000000
Food ball Pitch flood lights & associated work	S.P.O.	Al Seal	Wajbah	Food ball Pitch flood lights and associated work	1997	810000
Covered Car Parking	Qatar University	Do	University premises	Covered Car Parking	1999	1450000
Pipe and Installation Support	QASCO	Stream Industrial Engg	Umm Said	QASCO Pipe and Installation Support	1999	518000
Mirror Polished S.S. Cladding	City Centre	Gettco Contracting	City Centre	Mirror Polished Stainless Steel Cladding	2000	595340
Miscellaneous Steel	City Centre	Gettco Contracting	City Centre complex	Miscellaneous Steel	2000	1100000
Communication Towers	Ooredoo (Qtel)	Metalex	Miscellaneous	4 locations	2001	830000
Steel Framing	Sh Faisal	Gettco	City Center	Steel Framing for Women Entertainment area	2001	1102509
Steel work and cladding	Aluminium Technology	Metalex	Al Saad	Steel work and cladding for the Royal Plaza – upper roof and framing for Skylight	2002	1200000
Repairs to Amiri Flight Hangar	Qatar Airways	Metalex	Doha Airport	Repairs to Amiri Flight Hangar	2002	1947673
10 Monopoles	Ooredoo (Qtel)	Metalex	Various locations in Qatar	10 Monopoles	2002	1531000
Communication Towers	Ooredoo (Qtel)	Metalex	Various	Communication Towers	2002	2204800
Antique Book Shelving	National Council for Culture, Art and Heritage	Metalex	Doha	Steel Framing for Antique Book Shelving	2004	975000
Steel Work for 14 Cinemas	City Center	Gettco	City Center	Structural Steel Work for 14 Cinemas	2003	4390000
Monopoles	Ooredoo (Qtel)	Metalex	Various	Monopoles	2004	2432000
Structural Steel Work	Q.P.	Oriental Enterprises	Halul Island	Structural Steel Work	2004	3850000

PROJECT	CLIENT	PRIME CONTRACTOR	LOCATION	SCOPE OF WORKS	YEAR	VALUE
Steel Work, Crane and Hoists	Khalifa Sports City Development Energy Centre	Marbu Contg	Khalifa Sports City Development Energy Centre	Steel Work, Crane and Hoists	2004	1010960
Steel Framing for Villas	Doha Arabesque	Metalex	Doha	Steel Framing for Villas	2004	500000
Miscellaneous Metal Work	Drainage Dept	Al Huda Engg	Various	Miscellaneous Metal Work	2004	689943
Space Frame Roofing System	QNOC	Contraco	Al Rayyan Al Itihad Sports Clubs	Space Frame Roofing System	2004	4150000
80m Communication Tower	Ooredoo (Qtel)	Metalex	Halul Island	80m Communication Tower	2004	1347000
Modifications to Space Frame	QNOC	Tadmur	Al Hilalal	Modifications to Space Frame	2004	1200000
Tensile Canopies + Wind Towers	QNOC	Midmac	Khalifa Stadium	Tensile Canopies + Wind Towers	2004	1901920
Steel Framing & Decking	Mercedes Show Room	N.I.C.C.	Decoration R/A	Steel Framing & Decking	2004	525516
Conical Shaded Car Parking	Qatar University	Metalex	Qatar University	Conical Shaded Car Parking	2005	1841650
Steel framing to support Space frame	QNOC	I.T.C	Qatar Sports Club	Steel framing to support Space frame	2004	1250000
Tensile Fabric & Car Park Shades	QNOC	Midmac	Khalifa Orthopedic Sports Medicine Hospital	Tensile Fabric & Car Park Shades	2004	641000
Tensile Fabric Shades	QNOC	Contraco	Khalifa Stadium	Tensile Fabric Shades	2004	808840
Tensile canopies for Play Area	QNOC	Midmac	Khalifa Stadium	Tensile canopies for Play Area	2004	746500
Islamic Museum	Qatar Petroleum	Baytur	Corniche	Main Atrium, Steel Work, Shoring System, Re-shoring system	2005	7800000
Steel work	Ooredoo (Qtel)	Salam	West Bay	Steel work	2005	950000
Roof Framing System	QNOC	Hamad Bin Khalid Contracting Co.	Al Saad Sports Club	Roof Framing System	2005	17000000
Platforms and Walkways	QNOC	I.T.C.	Qatar Sports Club	Platforms and Walkways	2005	1360000
Platforms and Walkways	QNOC	Tadmur	Al Arabi Sports Club	Platforms and Walkways	2005	1685460
Modifications to Lighting Masts	QNOC	Darwish Trading	Qatar Sp Club and Al Arabi Sports Club	Modifications to Lighting Masts	2005	730000

PROJECT	CLIENT	PRIME CONTRACTOR	LOCATION	SCOPE OF WORKS	YEAR	VALUE
Modifications to Lighting Masts	QNOC	Darwish Trading	Qatar Sp Club and Al Arabi Sports Club	Modifications to Lighting Masts	2005	730000
Scissors Access Platform	Qatar Sports Club	I.T.C.	Qatar Sports Club	Scissors Access Platform	2005	605000
Steel work-New Marine Building	Qatar Petroleum	Oriental	Halul Island	Steel work-New Marine Bldg	2005	3800000
43m Monopoles	HMC	Metalex	Various	43m Monopoles	2006	900000
Modifications to High Mast	KSCDC	Metalex	Al Wajbah Palace	Modifications to High Mast	2006	841000
Roof System	QEWC	Gulf Housing	West Bay	Roof system	2006	7982920
Communication Tower	Doha Asian Games	Metalex	At Command Centre	Communication Tower at Command Centre	2006	2500000
10 Nos Monopoles	Ooredoo (Formerly Qtel)	Metalex	Various	Monopoles 10 Nos (30m Height) for GSM	2006	2534000
Flag Raising Mechanism	Doha Asian Games	Metalex	Various	Flag Raising Mechanism	2006	786000
Sail & Grid System	QWEC	Gulf Housing	West Bay	Sail & Grid System	2007	7301251
Light Masts Head Frames	QNOC	Marbu	Al Ahli, & Al Arabi Club	Light Masts Head Frames	2006	2208000
Velodrome at Aspire	Doha Asian Games	Metalex	Doha Asian Games Venue	Velodrome at Aspire	2006	4014202
Qatar Cool Tank Cover	Qatar Cool	Al Mana Engg	West Bay	Qatar Cool Tank Cover	2006	1800000
Platforms and Walkway	QNOC	Marbu	Al Wakrah	3 No Platforms & Walkway	2006	2720000
New Fire Station and Workshop	Qatar Petroleum	Oriental Ent.	Halul Island	Steel Framing & Wall and Roof cover for New Fire Station and Workshop	2009	10315950
Fabrication of floating buoys	United international	Metalex	Doha Port	Design, Fab. and Supply, of Floating Buoys	2007	1647588
Villaggio cinemas complex	Business trading company	Metalex	The Mall	steel framing and gypsum work	2009	16298762
Residential tower	Al seal	Metalex	West Bay	roof framing	2007	1100000
Development at wakrah and al khor clubs	QNOC	ITC	Al Wakrah, Al Khor, Al Ahli Sports clubs	Structural steel work	2007	2987600
Pedestrian bridge	QNOC	Marbu	Auto race track Industrial area	Design, fabrication, supply and erection	2007	2151000

PROJECT	CLIENT	PRIME CONTRACTOR	LOCATION	SCOPE OF WORKS	YEAR	VALUE
Residential building	Ahmed Al Majid	Metalex	Industrial Area	Structural steel work	2009	2429000
Wall louvers	Gulf Housing & Const. Co.	Metalex		Structural steel work	2009	3812480
Bin mahmoud residential building	Ahmed Al Majid	Metalex	Industrial Area	Structural steel work	2007	1590000
80m Comm. Tower	Ooredoo (Formerly Qtel)	Metalex	Halul Island	80m Communication Tower	2008	5131000
Qatar Cool Tank Cover	Qatar Cool	Al Mana Engg	West Bay	Cool Tank Cover and Structure	2008	675000
Laundry Facility at Industrial area	Derwind Trad & Contg. Co.	Metalex	New Industrial Area		2009	5475000
GTC 123 Kahramaa Phase VII Substations Sail	Kahramaa	Gulf Contracting Co.	Lusail	Design, Fabricate, Supply and Erection of Sail for Substations	2008	3600000
TV Screen Support	Doha Asian Games	Metalex	Khalifa Sport City	TV Screen Support	2006	998000
Steel structure for 2 Screens	Private	Salam Media-cast	Khalifa Stadium	Design and supply of Steel framing and mechanism for 2 Score board of 500 Kg.	2008	676000
Villaggio Cinema Suspension	Cineco	Metalex	The Mall	Suspension for services in Villaggio Cinema	2009	517708
Shade Structure	Al Jazeera Academy	Al Kaabi Contg.	Al Jazeera Academy	Design, fabrication and erection of Shade structure	2008	948141
Swimming pool	H.E. Shaikh Khalid	Metalex	Al Rayyan		2009	500000
Tensile shade Structure	Qatar Petroleum	Al Mana Engineering	Dukhan	Design, fabricate, paint, supply and erection	2009	1550000
Family Entertainment Center at Villaggio	Business Trading Company	Metalex	The Mall	Steel Framing and Decking	2009	2480000
Steel roof for multi storey car park at Dafna	ASHGHAL	Boom General Contractors	Dafna	Roof system, including the Curved cellular beams, purlins, standing seam, and aluminium cladding.	2009	4975500
Wall louvers	Kahrama	Gulf Contracting Co.	Dukhan	Structural steel work	2009	1629140
SS Mesh Support for 66kv and 220kv bldgs.	Kahrama	Gulf Contracting	Lusail	Fabrication, and erection of SS Mesh	2009	667060
Scissor Doors	Barwa	Marbu	Doha	Design, Fabricate and erecting of Scissor Doors	2009	3600000
Canopies and Shaded parking	Qatar Petroleum	Kbas	Ras Laffan	Design, Fabricate, paint and erecting of Canopies and car parking	2010	14804505

PROJECT	CLIENT	PRIME CONTRACTOR	LOCATION	SCOPE OF WORKS	YEAR	VALUE
Business Park	Sh. Mohamed Bin Hamad Al Thani	Redco-Al Mana	Duhail	Design, Fabricate and erecting of Canopies and car parking	2009	10000000
Car Parking Shades	MOI	Redco-Al Mana	Duhail	Design, Fabricate, paint and erecting of car parking shades	2009	793000
Hollow core beds	Qatar precast	Metalex	Industrial Area	Fabricate and install steel bed for hollow core slab	2009	1138500
Framing for Canopies	HE.Shk Hamad Bin Jassim Bin Jaber Althani	Al Seal	West Bay - Lagoon	Supply and Erection	2009	1000000
Louvers at Barwa	Kahrama	Siemens consortium	Abu Hamour	Design, fabricate, supply and erection of Aluminium Louvers	2009	606718
Wall Louvers	Kahrama	BUTEC	Al Khissa North	Design, fabricate, supply and erection of Aluminium Louvers	2009	1613409
Building -7	Medina Centrale	Power Line Engineering	The Peart Qatar	Steel work for building 7	2009	8200000
Roof System	QNOC	Arcon	Dhakira	Roof system at cultural center	2009	800000
Nobu Restaurant	Four Season Hotels	Terna	Doha	Structural steel work and Roof framing	2010	7835000
Dome and Architectural Metal Work	Private	Redco Al mana	Wajba Palace	Structural steel work and Roof framing	2010	1664000
Shade Structures	QNOC	ITC	Sumaisma & Barzan	Tensile shades and Stainless steel Sculptures	2010	4950000
Tents at Gulf Mall	H.E. Sheik Nasser bin Abdullah Al thani	Al Alia Trading and Contracting	Gharaffah	Supply, Erection and Commissioning of tensile tents	2010	2535000
Sails & Grid Sails	Kahrama	Green Top International	Lusail	Design, Fabricate, Supply and erection of sails and open grid sails	2010	6500000
Chamber covers	ASHGHAL	Lotus trad & contr	Doha	Design, Fabrication and supply of culvert covers	2010	761769
Doha stadium metal work	Private	Itc	Doha	Design, Fabricate and Erection of Steel framings	2010	710600
Aluminium covers	ASHGHAL	Al jaber engg	Doha	Design, Fabrication and supply of culvert covers	2010	1163455
Siemens ph-9 louvers	Kahrama	Gulf contracting co.,	Doha	Design, Fabrication and supply of culvert covers	2010	12625981
Sky light for new mall	Private	Q-glass	Doha	Design, Fabricate and Erection of Steel framings	2010	650000
Ezdan louvers	Kahrama	Gulf contracting co.,	Doha	Design, fabricate, supply and erection of Aluminium Louvers	2010	704694

PROJECT	CLIENT	PRIME CONTRACTOR	LOCATION	SCOPE OF WORKS	YEAR	VALUE
Al jiffara louvers	Kahrama	Gulf contracting co.,	Doha	Design, fabricate, supply and erection of Aluminium Louvers	2010	1307730
Trolley mechanism for pipes conveying	Barwa	Mace	Doha	Design, Fabrication and supply of Mechanism	2011	893380
Aspire tower top fire	Aspire	Marbu contracting	Doha	Design, Fabrication and supply of Mechanism	2011	2500000
Brass gates	Msherieb	Alutec	Doha	Design, fabricate, supply and erection of Brass gates	2011	15890301
Palm tower modification	Private	Al seal contracting	West Bay	Design, Fabricate and Erection of Steel framings	2011	1180613
Abu hamour mall - skylight framing	Private	Alutec	Doha	Design, Fabricate and Erection of Steel framings	2011	3000000
Courtyards shade structure	Qatar Foundation	Contraco	Doha	Design, Fabricate and Erection of Steel framings	2011	1104000
Silhouette tower spiral staircase	Intercontinental Hotels Group	Redco - al mana	Doha	Design, Fabricate and Erection of Glass stairs	2011	776200
Mall dome steel work	The Pearl	Power line engineering	The Pearl Qatar	Design, Fabricate and Erection of Steel framings	2011	750000
Ss cladding system	Commercial Bank	Amar construction	Doha	Fabricate and Erection of SS Clading	2011	550107
Steel structure for display screen	Private	Al ali proj. Co.	West End Park	Design, Fabricate and Erection of Steel framings	2011	741520
Sail & grid system	Kahrama	Gulf contracting co.,	Doha	Design, Fabricate and Erection of Steel framings	2012	2028457
Lifts and Bridges	Supreme Education Council	Al huda engg	Doha	Design, Fabricate and Erection of Steel structures	Current	9350000
Shades canopy at wgs education city	Qatar Foundation	Redco-al mana	Doha	Design, Fabricate, paint and erection of Canopies	Current	3000000
Ss staircase, ladders & handrails	ASHGHAL	Al jaber engg	Doha	Design, Fabricate and Erection of SS Staircase and Ladders	Current	526955
Aluminium covers	ASHGHAL	Lotus trad. & contr.	Doha	Design, Fabrication and supply of culvert covers	2012	555860
Exhibition panel fittings	Private	Al thulaiithi	Doha	Structural steel works	2012	750000
Skirt shades	Ghanem Al-Thani Holdings W.L.L.	Ramco	Doha	Design, Fabricate, paint and erection of shades	2012	2650000
Panoramic lift framing	Private	Q-glass	Doha	Structural steel works	2012	1000000



Steel Structural Multi-Storey Buildings

We Offer:

- ◆ Design, Fabrication and Erection of Structural and Architectural Metal Work.
- ◆ Design, Fabrication, Supply, Erection and Fire Proofing of Multi- Storey Buildings.
- ◆ Fabrication and Erection of Tensile Structures and Shades.
- ◆ Miscellaneous Metal Works for Sewage And Water supply Projects.



Steel Dome



Communication Masts and Towers



Louvered Wall

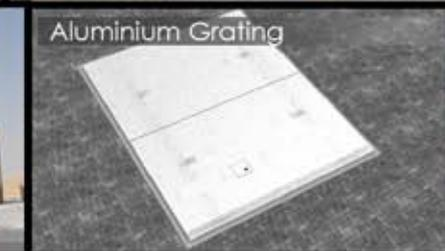

Aluminium Grating

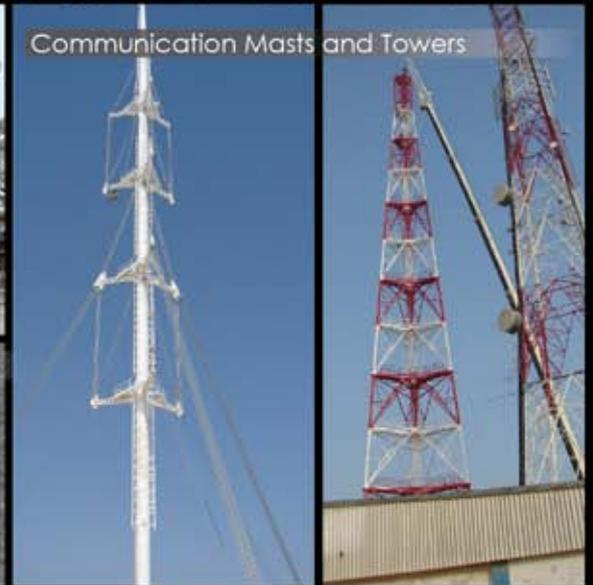

Pedestrian Bridges



Bicycle Velodrome



Tensile Shades



Metalex has a wide range of machinery for fabrications these include conventional cutting, drilling, shearing, punching, bending and painting machines as well as Computer Numeric control (CNC) machines such as Water Jet cutting machine (2m x 4m), Plasma cutting machines (3m x 13m) & (2m x 6m), Grooving machines (2m x 4m) and Laser cutting machine.

Metalex
 TRADING AND CONTRACTING CO. W.L.L
 RELIABLE | COMPETENT | COMMITTED | PROFESSIONAL

**Postal Address**

Metalex Trading and Contracting Co. W.L.L
Street No.43, Gate No.: 96
P.O.Box: 40710
Doha Industrial Area, Doha,
State of Qatar.

Telephone

(+974) 4450 3122
(+974) 4460 6579
(+974) 4460 2343

Fax

(+974) 4460 2344

E-mail

metalex@qatar.net.qa
metalex1@gmail.com

Website

www.metalex.com.qa